

Product Code

1040N/5A6

Solenoid Valve
5/8" Flare 220-230V
PS = 50 bar

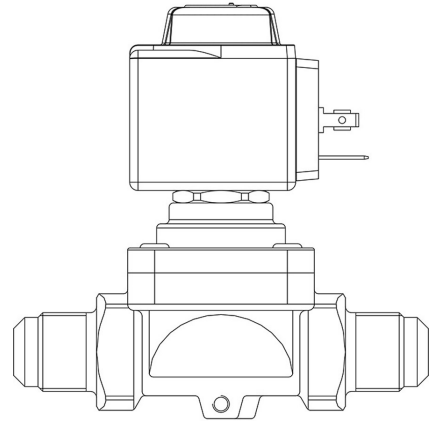

P  **LYHEDRA**

Product use

Accessories for use with the following ASHRAE 34:2019 refrigerants, Class A1, A2L, or A3:
 HFC (R134A, R32, R404A, R407C, R410A, R507)
 HFO (R1234YF, R1234ZE)
 HFO + HFC (R448A, R449A, R450A, R452A, R452B, R454A, R454B, R454C, R455A, R513A, R515A, R515B)
 HC (R290, R600, R600A, R1270)

These valves are sold in both the version without the coil (S suffix) and the version with the coil (A6 suffix for coils at 220 VAC).

Product details

Operating principle Piston pilot operated

Coil Type (1) HF2

Connections SAE Flare 5/8"

Kv [m³/h] 3

PS [bar] 50

TS [°C] min. -40

TS [°C] max. +130

Package Pcs. 24

Notes

(1) : coils mounted on the valves