

Product Code

1438E/M12S050

Solenoid Valve CO2

1/2" ODS w/o Coil

PS = 140 bar

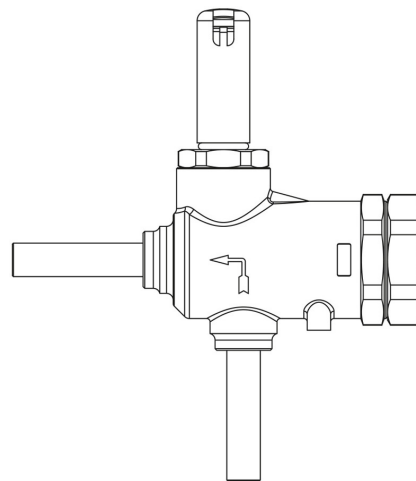

Product use

Accessories for use with refrigerant R744.

These valves are exclusively sold in the model without coil (S suffix).

Product details

Operating principle Piston pilot operated

Coil Type (1) HF3

Connections ODS Ø [in.] -

Connections ODS Ø [mm] 12

Kv [m³/h] 0,8

PS [bar] 140

MWP [psi] (4) 2030

TS [°C] min. -40

TS [°C] max. +150

Package Pcs. 14

Notes

(1) : coils that can be fit on the valves

(2) : for use on the oil line TS = -10 /+70 °C

Castel non si assume alcuna responsabilità per eventuali errori nei cataloghi, opuscoli e altro materiale stampato o indicato nel sito Castel.it. Castel si riserva il diritto di modificare i propri prodotti senza preavviso. Tutti i marchi in questo materiale sono di proprietà di Castel. Tutti i diritti riservati.

Castel assumes no responsibility for any errors in catalogs, brochures and other material printed or indicated on the Castel.it website. Castel reserves the right to modify its products without notice. All trademarks in this material are the property of Castel. All rights reserved.

(3) : for use on the oil line please contact CASTEL

(4): UL approval ongoing