

Product Code

1427E/3S030

Solenoid Valve CO2
3/8" ODS w/o Coil
PS = 130 bar

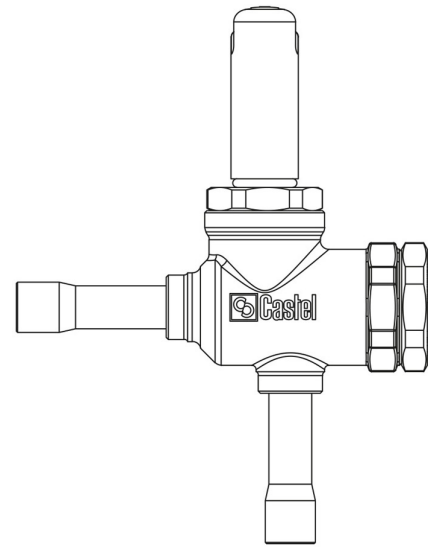

Product use

Accessories for use with refrigerant R744.
These valves are exclusively sold in the model without coil (S suffix).

Product details

Operating principle	Piston pilot operated
Coil Type (1)	HF3
Connections ODS Ø [in.]	3/8"
Connections ODS Ø [mm]	-
Kv [m ³ /h]	0,32
PS [bar]	130
MWP [psi] (4)	1885
TS [°C] min.	-40
TS [°C] max.	+150
Package Pcs.	14

Notes

- (1) : coils that can be fit on the valves
(2) : for use on the oil line TS = -10 /+70 °C

(3) : for use on the oil line please contact CASTEL

(4): UL approval ongoing