

Product Code

3133W/5

Check Valve

5/8"-16mm ODS

PS = 50 bar - 600 PSI

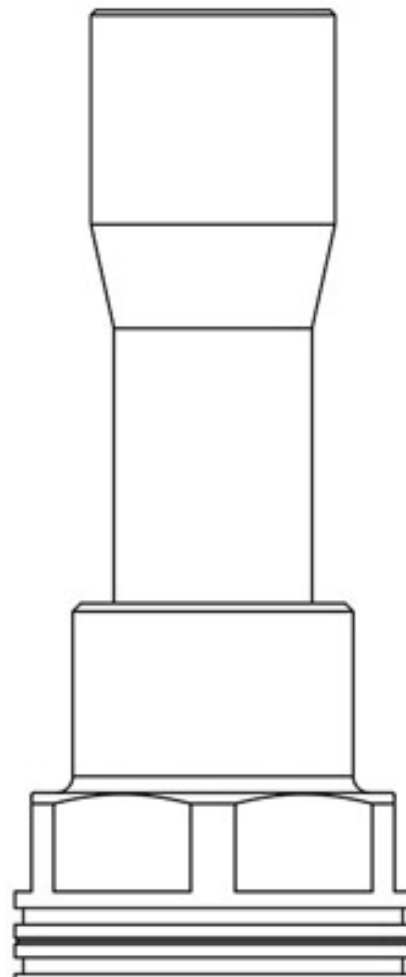

Product use

Accessories for use with the following ASHRAE 34:2019 refrigerants, Class A1, A2L, or A3:
 HFC (R134A, R32, R404A, R407C, R410A, R507)
 HFO (R1234YF, R1234ZE)
 HFO + HFC (R448A, R449A, R450A, R452A, R452B, R454A, R454B, R454C, R455A, R513A, R515A, R515B)
 HC (R290, R600, R600A, R1270)

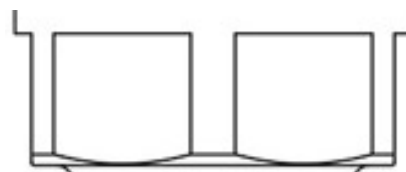

Product details

Connections SAE Flare	-
Connections ODS Ø [in.]	5/8"
ODS Ø [mm]	16
Kv [m ³ /h]	3,3
Differential pressure (2) [bar]	0,3
PS [bar]	50
MWP [psi] (1)	600
TS [°C] min.	-40
TS [°C] max.	+150

Notes

(1): according to UL approval

(2): minimum pressure at which the valve is completely open