

## Product Code

# 3138EW/M10

Check Valve CO2

10mm W

PS = 140 bar - 2030 PSI



### Product use

Accessories for use with refrigerant R744.

### Product details

Connections ODS Ø [in.] -

Connections ODS Ø [mm] -

W Ø [mm] 10

Kv [m<sup>3</sup>/h] 1,5

Differential pressure (2) [bar] 0,3

PS [bar] 140

MWP [psi] (1) 2030

TS [°C] min. -40

TS [°C] max. +150

Package pcs 25

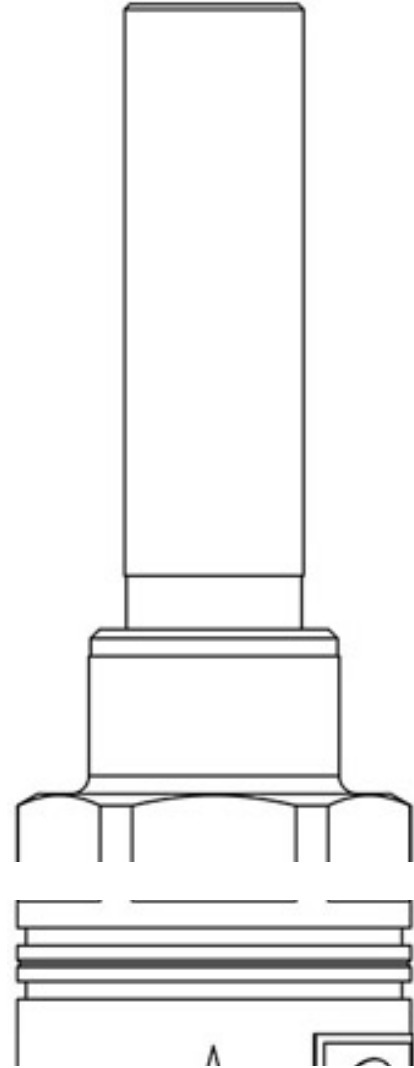

### Notes

(1): according to UL approval

(2): minimum pressure at which the valve is completely open.