

Product Code

5690/X11

Oil Level Regulator Adapter
Flanged 3 holes D. 1.7/8"-4 holes D. 50
PS = 140 bar

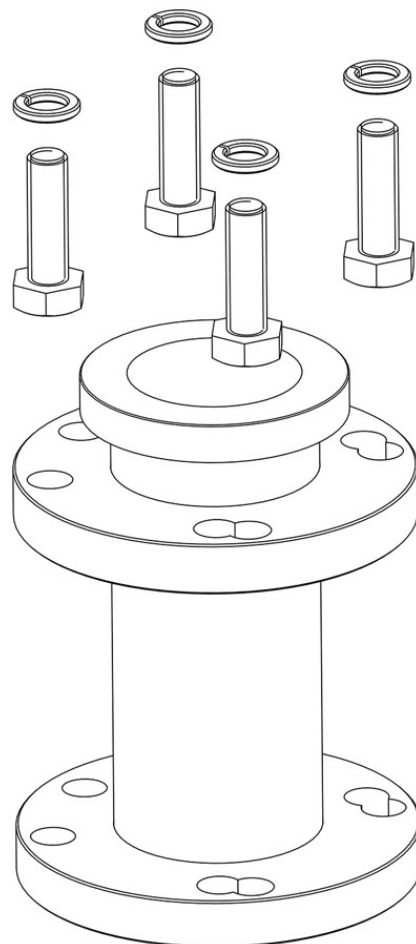

Product use

The oil level regulators ensure monitoring and control of the oil level in the crankcases of both alternative reciprocating and scroll compressors. Specifically, these regulators are employed to resolve the problem of incorrect oil distribution in multiple compressor plants.

Accessories for use with the following ASHRAE 34:2019 refrigerants, Class A1, A2L, or A3:

HCFC (R22)

HFC (R134A, R32, R404A, R407C, R410A, R507)

HFO (R1234YF, R1234ZE)

HFO + HFC (R448A, R449A, R450A, R452A, R452B, R454A, R454B, R454C, R455A, R513A, R515A, R515B)

HC (R290, R600, R600A, R1270)

Product details

Compressor crankcase connect Flanged with 3 holes on dia 1.7/8" and 4 holes on dia 50 mmL = 83 mm

Package pcs

5

Notes

(1) including screws for fixing the adapter to the oil level regulator