

Product Code

6210/4

Diaphragm Valve

1/2" Flare

PS = 28 bar

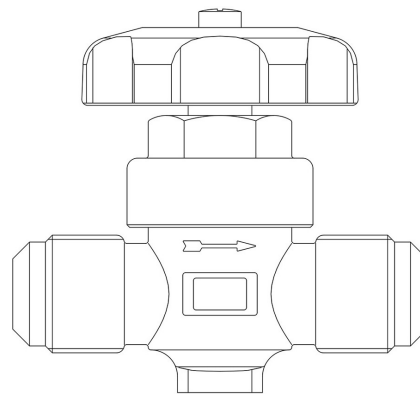

CLASSIC

Product use

Accessories for use with the following ASHRAE 34:2019 refrigerants, Class A1:

HCFC (R22)

HFC (R134a, R404A, R407C, R410A, R507)

HFO (R1234ze)

HFO + HFC (R448A, R449A, R450A, R452A, R513A, R515A, R515B)

Product details

Connections SAE Flare 1/2"

Connections ODS Ø [in.] -

ODS Ø [mm] -

Kv [m³/h] 1,3

PS [bar] 28

TS [°C] min. -35

TS [°C] max. +90

Package pcs 45