

Product Code

3124N/M22

Check Valve
22mm ODS
PS = 50 bar

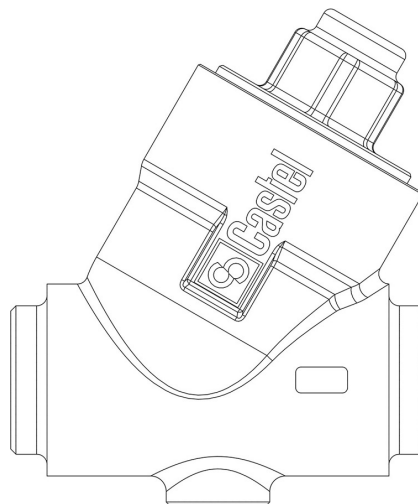

P  **LYHEDRA**

Product use

Accessories for use with the following ASHRAE 34:2019 refrigerants, Class A1, A2L, or A3:
HFC (R134A, R32, R404A, R407C, R410A, R507)
HFO (R1234YF, R1234ZE)
HFO + HFC (R448A, R449A, R450A, R452A, R452B, R454A, R454B, R454C, R455A, R513A, R515A, R515B)
HC (R290, R600, R600A, R1270)

Product details

Connections ODS Ø [in.]	-
Connections ODS Ø [mm]	22
ODM Ø [in.]	-
ODM Ø [mm]	28
Kv [m ³ /h]	8,1
differential pressure (1) [bar]	0,04
PS [bar]	50
TS [°C] min.	-40
TS [°C] max.	+150
Package pcs	14

Notes

(1) Minimum pressure at which the valve is completely open