

Product Code

6420N/2

Capped Valve

1/4"ODS

PS = 50 bar

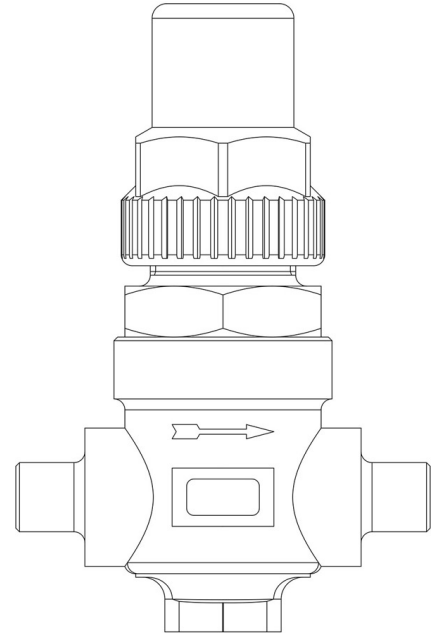

P  **LYHEDRA**

Product use

Accessories for use with the following ASHRAE 34:2019 refrigerants, Class A1, A2L, or A3:

HFC (R134A, R32, R404A, R407C, R410A, R507)

HFO (R1234YF, R1234ZE)

HFO + HFC (R448A, R449A, R450A, R452A, R452B, R454A, R454B, R454C, R455A, R513A, R515A, R515B)

HC (R290, R600, R600A, R1270)

Product details

Connections SAE Flare -

Connections ODS Ø [in.] 1/4"

ODS Ø [mm] -

Kv [m³/h] 0,4

PS[bar] 50

TS[°C] min. -40

TS[°C] max. +130

Package pcs 45