

Product Code

3310/5S

Hot Gas Bypass Capacity Regulator

5/8"-16mm ODS

PS = 28 bar - 405 PSI

CLASSIC

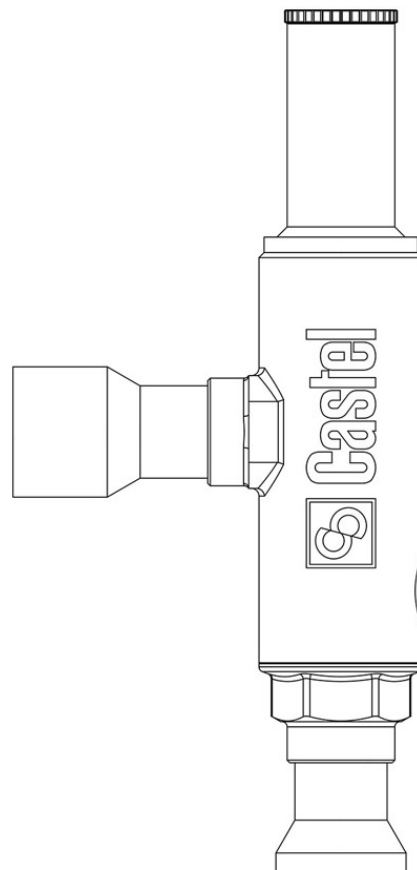

Product use

In refrigeration and air conditioning systems, it is preferable to limit the minimum evaporation pressure during periods of reduced load. Capacity regulators are a solution to these problems as they allow a portion of the hot discharge gas in the high pressure line to bypass directly to the low pressure line, returning the evaporation temperature/pressure to the desired value.

Accessories for use with the following ASHRAE 34:2019 refrigerants, Class A1:

HCFC (R22)

HFC (R134a, R404A, R407C, R410A, R507)

HFO (R1234ze)

HFO + HFC (R448A, R449A, R450A, R452A, R513A, R515A, R515B)

Product details

Connections SAE Flare	-
Connections Ø ODS [in.]	5/8"
Ø ODS [mm]	16
Regulation range [bar]	0,2 - 6
Kv [m ³ /h]	1,26
PS [bar]	28
MWP [psi] (1)	406
TS [°C] min.	- 40
TS [°C] max.	+ 110

Notes

(1): according to UL approval