

Product Code

3310/4

Hot Gas Bypass Capacity Regulator

1/2" Flare

PS = 28 bar - 405 PSI

CLASSIC

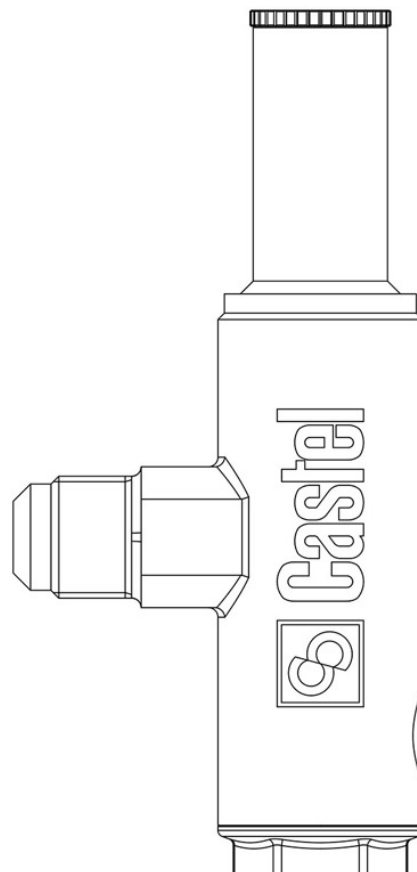

Product use

In refrigeration and air conditioning systems, it is preferable to limit the minimum evaporation pressure during periods of reduced load. Capacity regulators are a solution to these problems as they allow a portion of the hot discharge gas in the high pressure line to bypass directly to the low pressure line, returning the evaporation temperature/pressure to the desired value.

Accessories for use with the following ASHRAE 34:2019 refrigerants, Class A1:

HCFC (R22)

HFC (R134a, R404A, R407C, R410A, R507)

HFO (R1234ze)

HFO + HFC (R448A, R449A, R450A, R452A, R513A, R515A, R515B)

Product details

Connections SAE Flare 1/2"

Connections Ø ODS [in.] -

Ø ODS [mm] -

Regulation range [bar] 0,2 - 6

Kv [m³/h] 0,7

PS [bar] 28

MWP [psi] (1) 406

TS [°C] min. - 40

TS [°C] max. + 110

Notes

(1): according to UL approval