

## Product Code

# 3070/44C370

Bursting Disc Safety Device  
1/2"x1/2"NPT Pset=37,0bar  
PS = 55 bar

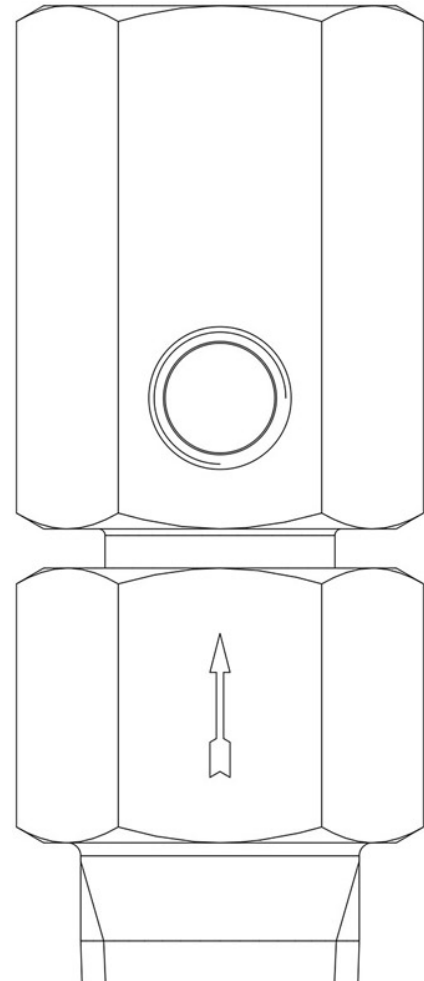

### Product use

Safety device 3070 is a pressure relief device that cannot be closed again, in which a bursting disc is sensitive to a positive differential pressure between the upstream and downstream sections. It is designed to burst at a specified pressure.

Safety accessories for use with the following ASHRAE 34:2019 refrigerants, Class A1:

HCFC (R22)

HFC (R134a, R404A, R407C, R410A, R507)

HFO (R1234ze)

HFO + HFC (R448A, R449A, R450A, R452A, R513A, R515A, R515B)

Available at various burst pressures from 14 to 52 bar.

### Product details

<b>Connections male IN</b>	1/2" NPT
<b>Connections female OUT</b>	1/2" NPT
<b>service</b>	2 x 1/8" NPT
<b>Orifice section [mm<sup>2</sup>]</b>	113
<b>Bursting pressure Pb [bar]</b>	37
<b>Max operating pressure</b>	75 % Pb
<b>PS[bar]</b>	55

<b>TS[°C] min.</b>	-50
<b>TS[°C] max.</b>	+150
<b>Package pcs</b>	20