

Product Code

6690NM/6A6

3-Ways Motorized Ball Valve-polyhedra

3/4" ODS 230V

PS = 50 bar

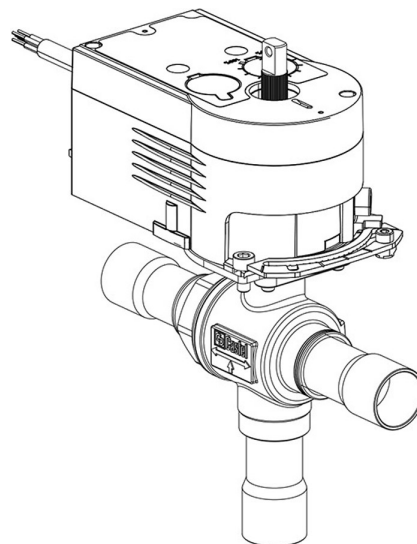

Product use

Accessories for use with the following ASHRAE 34:2019 refrigerants, Class A1, A2L, A3:

HFC (R134A, R32, R404A, R407C, R410A, R507)

HFO (R1234YF, R1234ZE)

HFO + HFC (R448A, R449A, R450A, R452A, R452B, R454A, R454B, R454C, R455A, R513A, R515A, R515B)

HC (R290, R600, R600A, R1270)

Product details

Part number (1) 6690NM/6A6

Part number (1)

Connections ODS Ø [in.] 3/4"

Connections ODS Ø [mm] -

W Ø [mm] -

P/N Servomotor 9700/RA6

Torque [Nm] 10

Ball port Ø [mm] 13,5

Kv [m³/h] 4,6

PS [bar] 50

TS [°C] min. -40

TS [°C] max. +150

Package pcs 1

Notes

NB: proportional flow versions available
(1): with servomotor and mounting plate