

Product Code

6697EM/7A2

3-Ways Motorized Ball Valve CO2

7/8" ODS 24V

PS = 130 bar

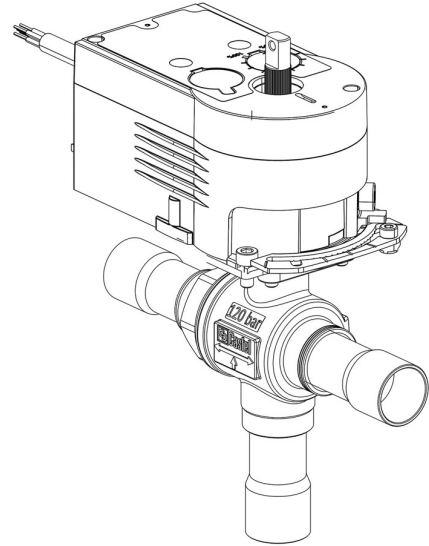

Product use

Accessories for use with refrigerant R744.

Product details

Part number (1) 6697EM/7A2

Part number (1)

Connections ODS Ø [in.] 7/8"

Connections ODS Ø [mm] 22

W Ø [mm] -

P/N Actuator 9700/RA2

Torque [Nm] 10

Ball port Ø [mm] 19

Kv [m³/h] 10,7

PS [bar] 130

TS [°C] min. -40

TS [°C] max. +150

Package pcs 1

Notes

(1): including actuator and mounting plate

NB: proportional flow versions available