

Product Code

6690M/9A2

3-Ways Motorized Ball Valve

1.1/8" ODS 24V

PS = 45 bar

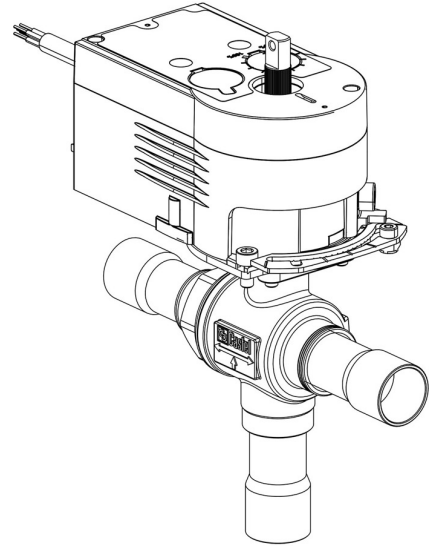

CLASSIC

Product use

Accessories for use with the following ASHRAE 34:2019 refrigerants, Class A1:

HCFC (R22)

HFC (R134a, R404A, R407C, R410A, R507)

HFO (R1234ze)

HFO + HFC (R448A, R449A, R450A, R452A, R513A, R515A, R515B)

Product details

Part number (1) 6690M/9A2

Part number (1)

Connections ODS Ø [in.] 1.1/8"

Connections ODS Ø [mm] -

W Ø [mm] -

P/N Servomotor 9700/RA2

Torque [Nm] 10

Ball port Ø [mm] 24

Kv[m³/h] 15,9

PS[bar] 45

TS[°C] min. -40

TS[°C] max.	+150
-------------	------

Package pcs	1
-------------	---

Notes

NB: proportional flow versions available
(1): with servomotor and mounting plate