

Product Code

**6110N/33**

Receiver Valve  
3/8"Flarex3/8"NPT  
PS = 50 bar

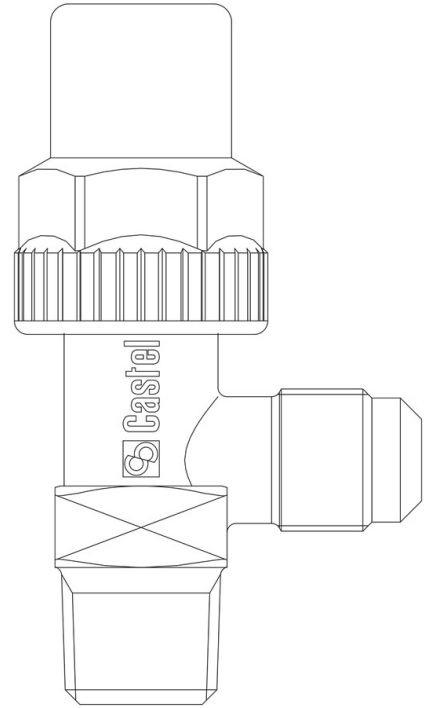

### Product use

Accessories for use with the following ASHRAE 34:2019 refrigerants, Class A1, A2L, or A3:  
 HFC (R134A, R32, R404A, R407C, R410A, R507)  
 HFO (R1234YF, R1234ZE)  
 HFO + HFC (R448A, R449A, R450A, R452A, R452B, R454A, R454B, R454C, R455A, R513A, R515A, R515B)  
 HC (R290, R600, R600A, R1270)

### Product details

|                          |      |
|--------------------------|------|
| Access fitting SAE Flare | -    |
| Connections SAE Flare    | 3/8" |
| Connections NPT          | 3/8" |
| Kv [m <sup>3</sup> /h]   | 1,35 |
| PS [bar]                 | 50   |
| TS [°C] min.             | -40  |
| TS [°C] max.             | +150 |
| Package pcs              | 90   |