

Product Code

6110/54

Receiver Valve
5/8"Flarex1/2"NPT
PS = 45 bar

CLASSIC

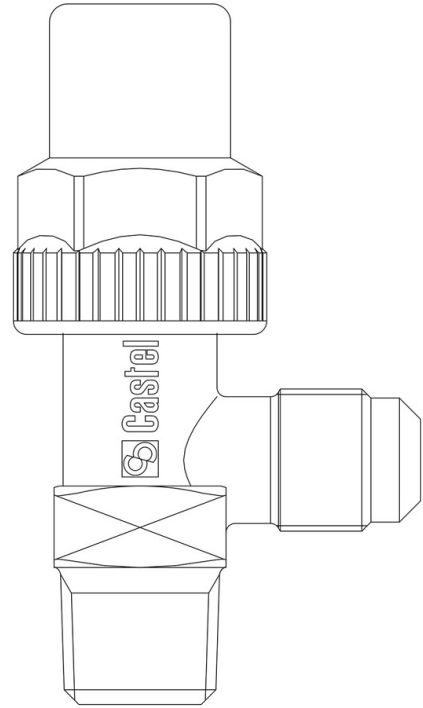

Product use

Accessories for use with the following ASHRAE 34:2019 refrigerants, Class A1:

HCFC (R22)

HFC (R134a, R404A, R407C, R410A, R507)

HFO (R1234ze)

HFO + HFC (R448A, R449A, R450A, R452A, R513A, R515A, R515B)

Product details

Access fitting SAE Flare -

Connections SAE Flare 5/8"

Connections NPT 1/2"

Kv [m³/h] 3,4

PS [bar] 45

TS [°C] min. -40

TS [°C] max. +130

Package pcs 20