

Product Code

2028/M12S07

PWM Expansion Valve
12mmx16mm ODS Seat 07
PS = 45 bar

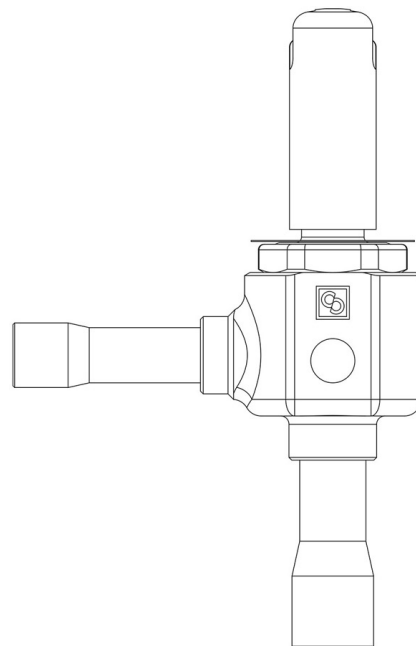

CLASSIC

Product use

Accessories for use with the following ASHRAE 34:2019 refrigerants, Class A1:

HCFC (R22)

HFC (R134a, R404A, R407C, R410A, R507)

HFO (R1234ze)

HFO + HFC (R448A, R449A, R450A, R452A, R513A,
R515A, R515B)

These valves are only sold in the model without the coil (S suffix), with 9 nozzles assembled for an increasing output from 1 to 22 kW with R410A.

Product details

Orifice type 07

Connections In Ø [in.] -

Connections In Ø [mm] 12

Out Ø [in.] -

Out Ø [mm] 16

Kv [m³/h] 0,2

PS [bar] 45

TS [°C] min. -40

TS [°C] max. +100

Notes

for rated capacities see table of the orifice assemblies