

Product Code

1178N/M12S

Solenoid Valve NO
12mm ODS w/o Coil
PS = 50 bar

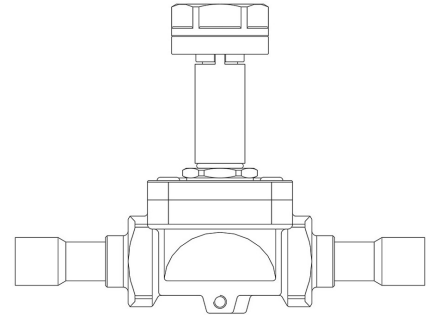

P  **LYHEDRA**

Product use

Accessories for use with the following ASHRAE 34:2019 refrigerants, Class A1, A2L, or A3:
HFC (R134A, R32, R404A, R407C, R410A, R507)
HFO (R1234YF, R1234ZE)
HFO + HFC (R448A, R449A, R450A, R452A, R452B, R454A, R454B, R454C, R455A, R513A, R515A, R515B)
HC (R290, R600, R600A, R1270)

These valves are exclusively sold in the model without coil (S suffix).

Product details

Operating principle	Diaphragm pilot operated
Coil Type (1)	HM3
Connections ODS Ø [in.]	-
Connections ODS Ø [mm]	12
Kv [m³/h]	2,2
PS [bar]	50
TS [°C] min.	-40
TS [°C] max.	+120
Package Pcs.	14

Notes

The N.O. valves have been designed to work only with direct current coil.

To use them with an alternate current supply it's necessary to mate the N.O. valve with the 9120/RD6 coil and the connector 9150/R45

(1) : coils that can be mounted on the valves