

Product Code

1049N/7A6

Solenoid Valve
7/8"-22mm ODS 220-230V
PS = 50 bar

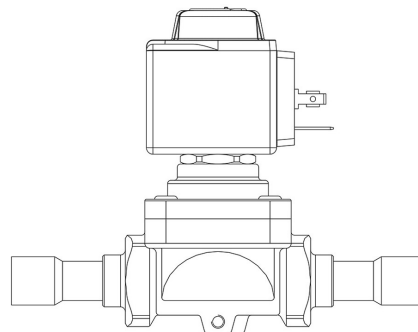

P  **LYHEDRA**

Product use

Accessories for use with the following ASHRAE 34:2019 refrigerants, Class A1, A2L, or A3:
 HFC (R134A, R32, R404A, R407C, R410A, R507)
 HFO (R1234YF, R1234ZE)
 HFO + HFC (R448A, R449A, R450A, R452A, R452B, R454A, R454B, R454C, R455A, R513A, R515A, R515B)
 HC (R290, R600, R600A, R1270)

These valves are sold in both the version without the coil (S suffix) and the version with the coil (A6 suffix for coils at 220 VAC).

Product details

Operating principle	Piston pilot operated
Coil Type (1)	HF2
Connections ODS Ø [in.]	7/8"
Connections ODS Ø [mm]	22
Kv [m³/h]	3
PS [bar]	50
TS [°C] min.	-40
TS [°C] max.	+130
Package Pcs.	14

Notes

(1) : coils mounted on the valves