

## Product Code

# 1020N/3A6

Solenoid Valve  
3/8" Flare 220-230V  
PS = 50 bar

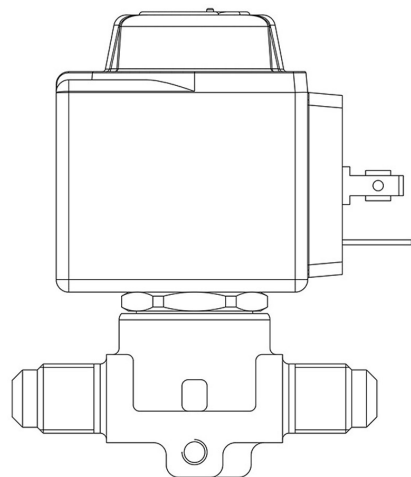

**P**  **LYHEDRA**

### Product use

Accessories for use with the following ASHRAE 34:2019 refrigerants, Class A1, A2L, or A3:  
 HFC (R134A, R32, R404A, R407C, R410A, R507)  
 HFO (R1234YF, R1234ZE)  
 HFO + HFC (R448A, R449A, R450A, R452A, R452B, R454A, R454B, R454C, R455A, R513A, R515A, R515B)  
 HC (R290, R600, R600A, R1270)

These valves are sold in both the version without the coil (S suffix) and the version with the coil (A6 suffix for coils at 220 VAC).

### Product details

**Operating principle** Direct acting

**Coil Type (1)** HF2

**Connections SAE Flare** 3/8"

**Kv [m<sup>3</sup>/h]** 0,23

**PS [bar]** 50

**TS [°C] min.** -40

**TS [°C] max.** +130

**Package Pcs.** 18

## Notes

(1) : coils mounted on the valves