

Product Code

1038EL/4S

Solenoid Valve CO2

1/2"ODS w/o Coil

PS = 60 bar

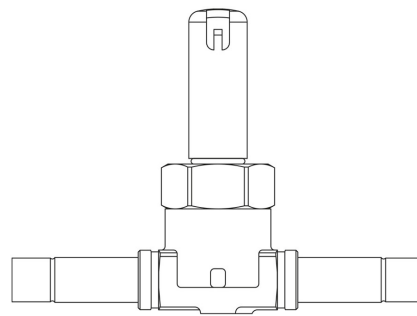

Product use

Accessories for use with refrigerant R744.

These valves are exclusively sold in the model without coil (S suffix).

Product details

Operating principle Piston pilot operated

Coil Type (1) HF3 (HM3)

Connections ODS Ø [in.] 1/2"

Connections ODS Ø [mm] -

Kv [m³/h] 1

PS [bar] 60

TS [°C] min. -40

TS [°C] max. +130

Package Pcs. 24

Notes

(1) : coils that can be fit on the valves