

## Product Code

# 3780/7

Moisture Indicator Saddle Type

pipe 22mm

PS = 45 bar

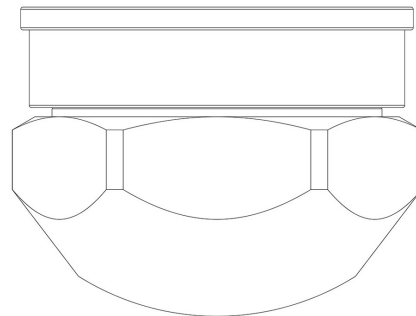

CLASSIC

### Product use

Accessories for use with the following ASHRAE 34:2019 refrigerants, Class A1:

HCFC (R22)

HFC (R134a, R404A, R407C, R410A, R507)

HFO (R1234ze)

HFO + HFC (R448A, R449A, R450A, R452A, R513A, R515A, R515B)

### Product details

Connections ODS Ø [in.] -

Connections ODS Ø [mm] -

ODM Ø [in.] -

ODM Ø [mm] -

For pipe Ø [in.] 7/8"

For pipe Ø [mm] 22

Hole Ø [mm] -

PS [bar] 45

TS [°C] min. -30

TS [°C] max. +110

Package pcs 120