

## Product Code

# 3138EW/M16

Check Valve CO2

16mm W

PS = 140 bar - 2030 PSI

**G O G R E E N**

R744 • NATURAL REFRIGERANT

### Product use

Accessories for use with refrigerant R744.

### Product details

Connections ODS Ø [in.] -

Connections ODS Ø [mm] -

W Ø [mm] 16

Kv [m<sup>3</sup>/h] 3,3

Differential pressure (2) [bar] 0,3

PS [bar] 140

MWP [psi] (1) 2030

TS [°C] min. -40

TS [°C] max. +150

Package pcs 16

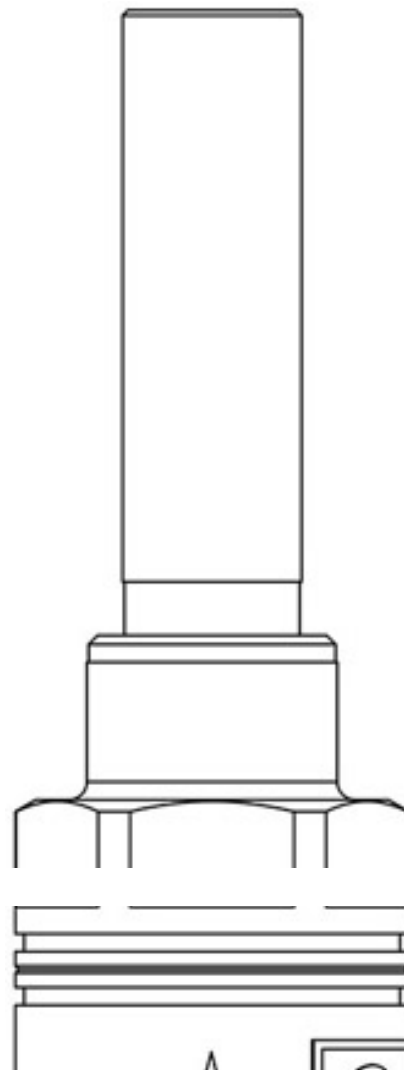

### Notes

(1): according to UL approval

(2): minimum pressure at which the valve is completely open.