

Product Code

3137EW/2

Check Valve CO2

1/4"ODS

PS = 130 bar - 1740 PSI

G O G R E E N

R744 • NATURAL REFRIGERANT

Product use

Accessories for use with refrigerant R744.

Product details

Connections ODS Ø [in.] 1/4"

Connections ODS Ø [mm] -

W Ø [mm] -

Kv [m³/h] 0,5

Differential pressure (2) [bar] 0,3

PS [bar] 130

MWP [psi] (1) 1740

TS [°C] min. -40

TS [°C] max. +150

Package pcs 25

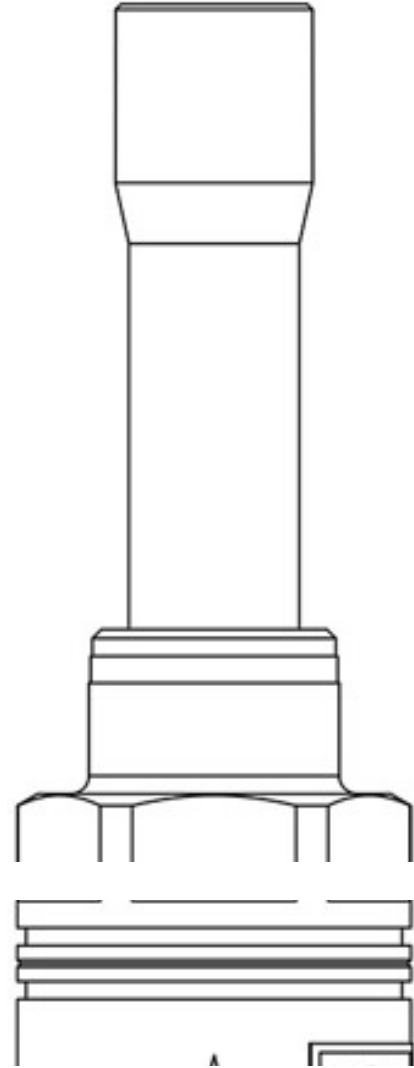

Notes

(1): according to UL approval

(2): minimum pressure at which the valve is completely open.