

Product Code

3132EW/M12

Check Valve CO2

12mm ODS

PS = 80 bar - 1160 PSI



Product use

Accessories for use with refrigerant R744.

Product details

Connections ODS Ø [in.] -

Connections ODS Ø [mm] 12

W Ø [mm] -

Kv [m³/h] 1,8

Differential pressure (2) [bar] 0,04

PS [bar] 80

MWP [psi] (1) 1160

TS [°C] min. -40

TS [°C] max. +150

Package pcs 16

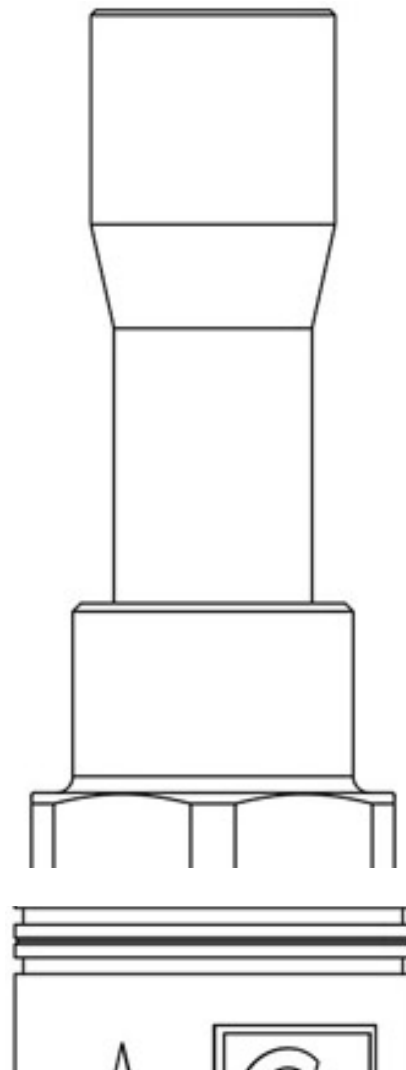

Notes

(1): according to UL approval

(2): minimum pressure at which the valve is completely open.