

Product Code

3133W/7

Check Valve

7/8"-22mm ODS

PS = 50 bar - 600 PSI

POLYHEDRA

CLASSIC

Product use

Accessories for use with the following ASHRAE 34:2019 refrigerants, Class A1:

HCFC (R22)

HFC (R134a, R404A, R407C, R410A, R507)

HFO (R1234ze)

HFO + HFC (R448A, R449A, R450A, R452A, R513A, R515A, R515B)

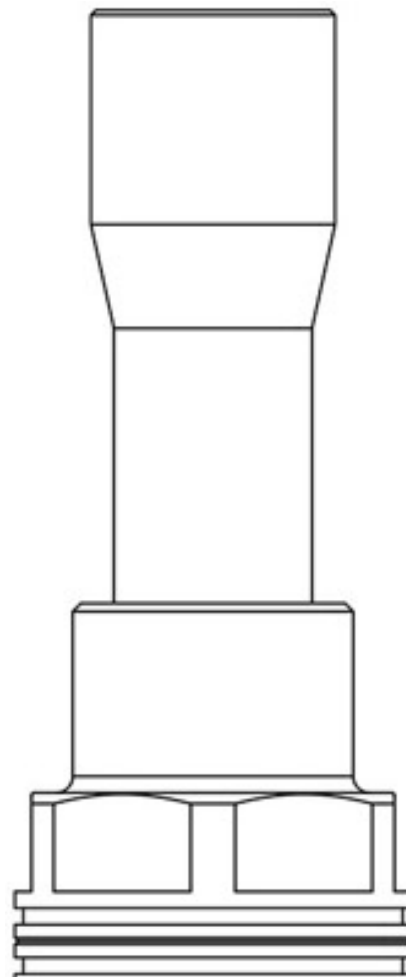

Product details

Connections SAE Flare -

Connections ODS Ø [in.] 7/8"

ODS Ø [mm] 22

Kv [m³/h] 5

Differential pressure (2) [bar] 0,3

PS [bar] 50

MWP [psi] (1) 600

TS [°C] Min -40

TS [°C] Max +150

Package pcs 21



Notes

(1): according to UL approval

(2): minimum pressure at which the valve is completely open.