

Product Code

3133W/6

Check Valve

3/4" ODS

PS = 50 bar - 600 PSI

POLYHEDRA

CLASSIC

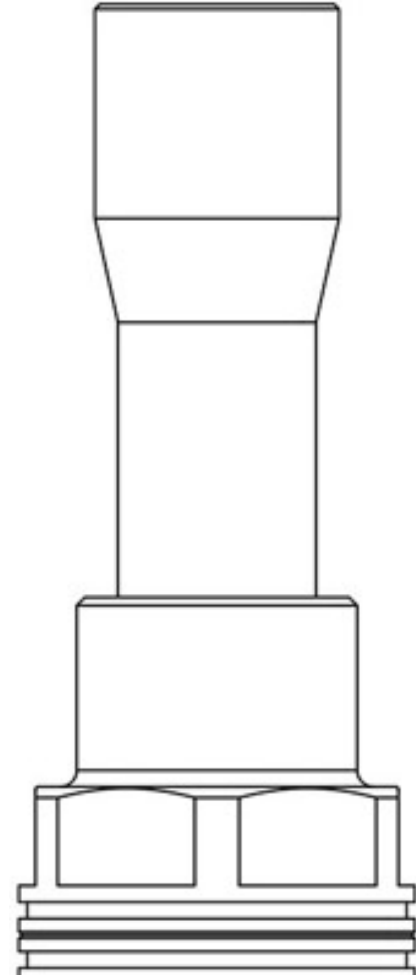

Product use

Accessories for use with the following ASHRAE 34:2019 refrigerants, Class A1:

HCFC (R22)

HFC (R134a, R404A, R407C, R410A, R507)

HFO (R1234ze)

HFO + HFC (R448A, R449A, R450A, R452A, R513A, R515A, R515B)



Product details

Connections SAE Flare -

Connections ODS Ø [in.] 3/4"

ODS Ø [mm] -

Kv [m³/h] 5

Differential pressure (2) [bar] 0,3

PS [bar] 50

MWP [psi] (1) 600

TS [°C] Min -40

TS [°C] Max +150

Package pcs 21

Castel non si assume alcuna responsabilità per eventuali errori nei cataloghi, opuscoli e altro materiale stampato o indicato nel sito Castel.it. Castel si riserva il diritto di modificare i propri prodotti senza preavviso. Tutti i marchi in questo materiale sono di proprietà di Castel. Tutti i diritti riservati.

Castel assumes no responsibility for any errors in catalogs, brochures and other material printed or indicated on the Castel.it website. Castel reserves the right to modify its products without notice. All trademarks in this material are the property of Castel. All rights reserved.

Notes

(1): according to UL approval

(2): minimum pressure at which the valve is completely open.