

Product Code

2028EX/3A603

PWM Expansion Valve - ATEX
3/8"x1/2"ODS Seat 02 - 220/230V
PS = 50 bar

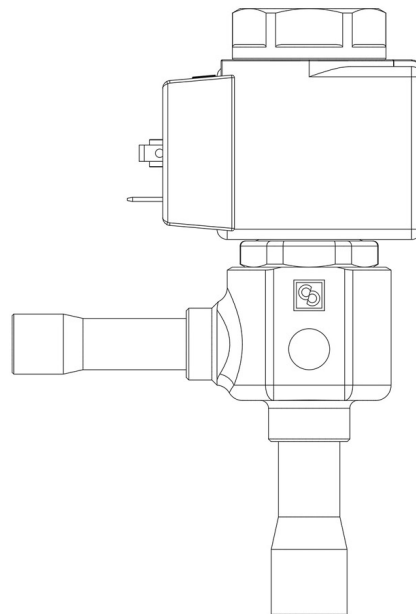

P  **LYHEDRA**

Product use

Solenoid expansion valves with the "EX" suffix are compliant with the ESR of Directive 2014/34/EU "ATEX". This equipment is suitable for use on refrigeration systems located in areas classified as "Zone 2" risk of explosion, according to the definition in Annex I of Directive 1999/92/EC.

Accessories for use with the following ASHRAE 34:2019 refrigerants, Class A1, A2L, or A3:

HFC (R134A, R32, R404A, R407C, R410A, R507)

HFO (R1234YF, R1234ZE)

HFO + HFC (R448A, R449A, R450A, R452A, R452B, R454A,

R454B, R454C, R455A, R513A, R515A, R515B)

HC (R290, R600, R600A, R1270)

These valves are only sold in the model with the ATEX certified coil (A6 suffix), with 9 nozzles assembled for an increasing output from 2 to 36 kW with R290.

Product details

Orifice type 03

Connections In Ø [in.] 3/8"

Connections In Ø [mm] -

Out Ø [in.] 1/2"

Out Ø [mm] -

Kv [m³/h] 0,023

PS [bar] 50

TS [°C] min.	-40
TS [°C] max.	+100
Package pcs.	15

Notes

for rated capacities see table of the orifice assemblies