

Product Code

9740/RA2

Electrical Actuator
100Nm 24V 50/60Hz

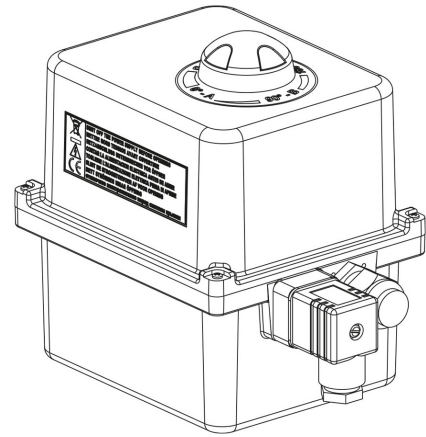

POLYHEDRA

CLASSIC

Product use

Actuators can be assembled, using suitable flanged adaptors, to 2-ways ball valves and to manual 3-ways ball valves. They are assembled directly on the motorized 3-ways ball valves. Once this coupling has been performed, the valve can be opened or closed remotely. Alternatively, the actuator can be excluded and the valve can be operated manually.

Castel manufacturers actuator with a variety of operational characteristics: they are manufactured with a synthetic, self-extinguishing housing that covers the motor, the control and cut-out electronics based on the gear reducer torque and the self centring fixing system of the valve rod.

In the event of a power outage to the actuator, the gear reducer can be disengaged using the specific lever, to permit manual use of the valve.

Furthermore, auxiliary contacts for switching are available for remote control of the valve status.

Product details

Voltage [V]	24
Frequency [Hz]	50/60
Power [W]	45
Degree of protection	IP 66
Rotation angle	90°
Torque [Nm]	100
Running time [sec]	120

Ambient temperature [°C] min. -10

Ambient temperature [°C] max. +55

Suitable for ball valve see the couplings indicated in the COUPLING SCHEME table

Package Pcs. 1

Notes

- (1) Wiring connections : switching output 2 points (open/close) or continuous output (0 ÷ 10V)
- (2) Wiring connections : switching output 2 points (open/close)
- (3) Wiring connections : continuous output (0 ÷ 10V)