

Product Code

6690EM/M42A6

3-Ways Motorized Ball Valve CO2

42mm ODS 230V

PS = 80 bar

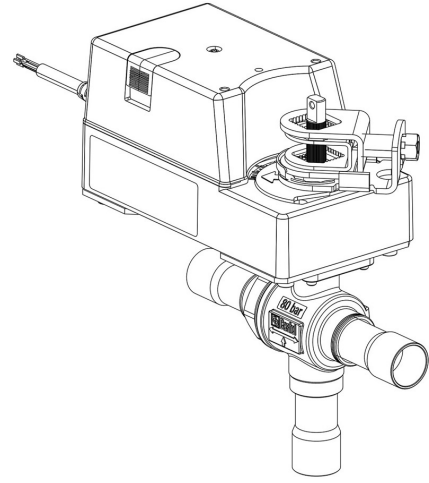

Product use

Accessories for use with refrigerant R744.

Product details

Part number (1) 6690EM/M42A6

Part number (1)

Connections ODS Ø [in.] -

Connections ODS Ø [mm] 42

W Ø [mm] -

P/N Actuator 9720/RA6

Torque [Nm] 30

Ball port Ø [mm] 37

Kv [m³/h] 38,5

PS [bar] 80

TS [°C] min. -40

TS [°C] max. +150

Package pcs 1

Notes

(1): including actuator and mounting plate

NB: proportional flow versions available