

## Product Code

# 6690M/M18A2

3-Ways Motorized Ball Valve

18mm ODS 24V

PS = 45 bar

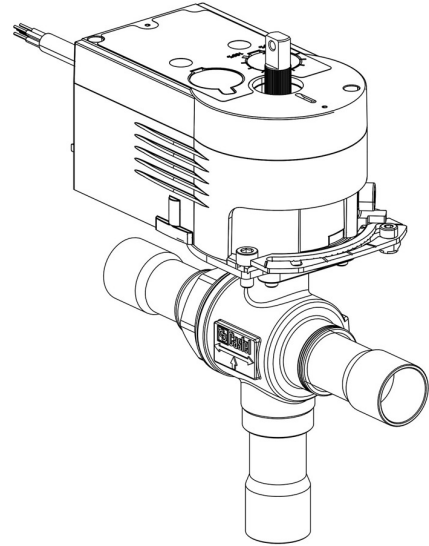

### Product use

Accessories for use with the following ASHRAE 34:2019 refrigerants, Class A1:

HCFC (R22)

HFC (R134a, R404A, R407C, R410A, R507)

HFO (R1234ze)

HFO + HFC (R448A, R449A, R450A, R452A, R513A, R515A, R515B)

### Product details

**Part number (1)** 6690M/M18A2

**Part number (1)** NEW

**Connections ODS Ø [in.]** -

**Connections ODS Ø [mm]** 18

**W Ø [mm]** -

**P/N Servomotor** 9700/RA2

**Torque [Nm]** 10

**Ball port Ø [mm]** 13,5

**Kv[m<sup>3</sup>/h]** 4,6

**PS[bar]** 45

**TS[°C] min.** -40

**TS[°C] max.** +150

**Package pcs** 1

## Notes

NB: proportional flow versions available  
(1): with servomotor and mounting plate