

Product Code

**6110E/44**

Receiver Valve CO2

1/2"FlareX1/2"NPT

PS = 140 bar

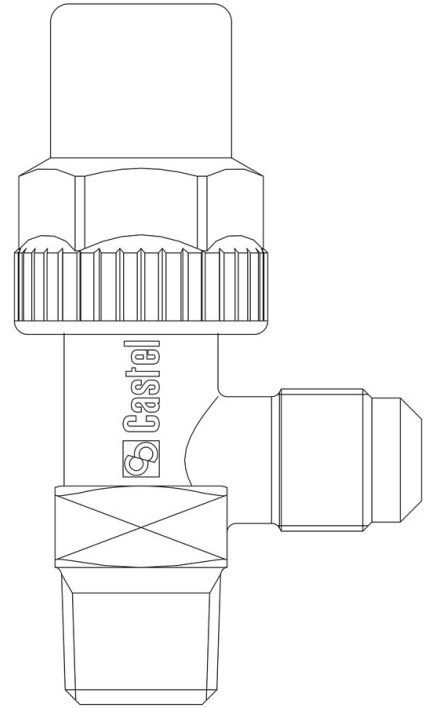

## Product use

Accessories for use with refrigerant R744.

## Product details

Connections SAE Flare -

Connections SAE Flare 1/2"

NPT 1/2"

NPT -

Kv [m<sup>3</sup>/h] 3,4

PS [bar] 140

MWP [psi] (3) 2030

TS [°C] min. -40

TS [°C] max. +130

Package pcs 20

## Notes

(1): including a conical gasket 7580/2

(2): can be installed without gasket

(3): UL approval ongoing