

Product Code

6020/233

Three Ways Hermetic Valve

3/8" Flare

PS = 45 bar

CLASSIC

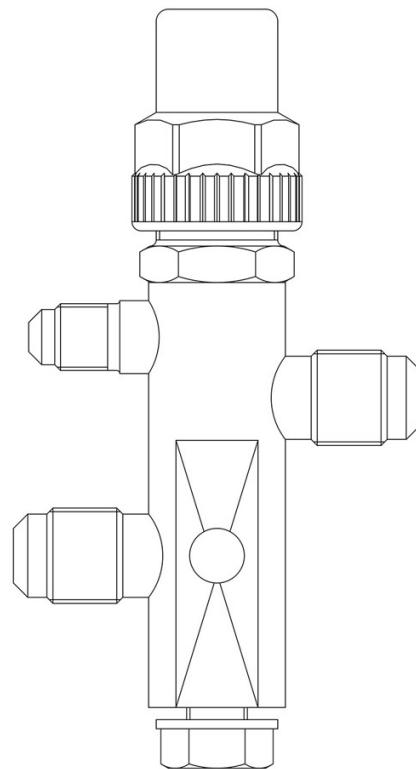

Product use

Accessories for use with the following ASHRAE 34:2019 refrigerants, Class A1:

HCFC (R22)

HFC (R134a, R404A, R407C, R410A, R507)

HFO (R1234ze)

HFO + HFC (R448A, R449A, R450A, R452A, R513A, R515A, R515B)

Product details

Access fitting SAE Flare 1/4"

Connections SAE Flare 3/8"

Connections SAE Flare 3/8"

ODS Ø [in.] -

ODS Ø [mm] -

Kv[m³/h] 1,2

PS[bar] 45

TS[°C] Min -40

TS[°C] Max +110

Package pcs 40