

Product Code

2028R/4S09

PWM Expansion Valve VLT R23

1/2"x5/8" ODS Seat 09

PS = 45 bar

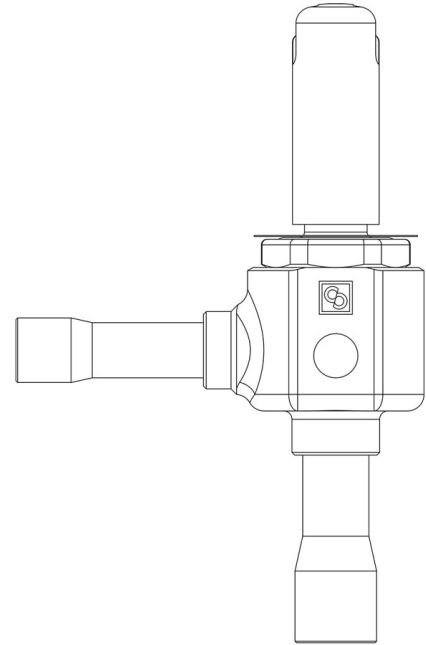

CLASSIC

Product use

Accessories for use with the following ASHRAE 34:2019 refrigerants, Class A1:

HCFC (R22)

HFC (R134a, R404A, R407C, R410A, R507)

HFO (R1234ze)

HFO + HFC (R448A, R449A, R450A, R452A, R513A,
R515A, R515B)

These valves are only sold in the model without the coil (S suffix), with 9 nozzles assembled for an increasing output from 1 to 22 kW with R410A.

Product details

Orifice type	09
Connections In Ø [in.]	1/2"
Connections In Ø [mm]	-
Out Ø [in.]	5/8"
Out Ø [mm]	-
Kv [m ³ /h]	0,25
Rated capacity R23 (1) [kW]	28,6
PS [bar]	45
TS [°C] min.	-80

TS [°C] max.	+60
--------------	-----

Package pcs.	17
--------------	----

Notes

(1) Rated capacities are based on:

- Evaporating temperature $T_{\text{evap}} = -30\text{ °C}$
- Condensing temperature $T_{\text{cond}} = -4\text{ °C}$
- Refrigerant liquid temperature ahead of valve $T_{\text{liq}} = -8\text{ °C}$