

Product Code

1038EL/M10S

Solenoid Valve CO2
10mm ODS w/o Coil
PS = 60 bar

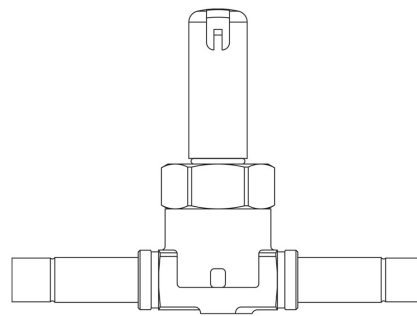

Product use

Accessories for use with refrigerant R744.
These valves are exclusively sold in the model without coil (S suffix).

Product details

Operating principle	Piston pilot operated
Coil Type (1)	HF3 (HM3)
Connections ODS Ø [in.]	-
Connections ODS Ø [mm]	10
Kv [m³/h]	1
PS [bar]	60
TS [°C] min.	-40
TS [°C] max.	+130
Package Pcs.	24

Notes

(1) : coils that can be fit on the valves