

Product Code

3133W/M10

Check Valve

10mm ODS

PS = 50 bar - 600 PSI

POLYHEDRA

CLASSIC

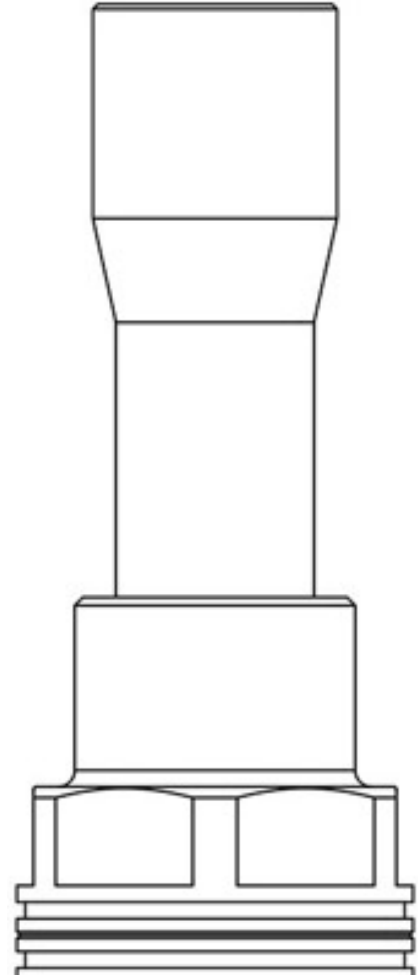

Product use

Accessories for use with the following ASHRAE 34:2019 refrigerants, Class A1, A2L, or A3:

HFC (R134A, R32, R404A, R407C, R410A, R507)

HFO (R1234YF, R1234ZE)

HFO + HFC (R448A, R449A, R450A, R452A, R452B, R454A, R454B, R454C, R455A, R513A, R515A, R515B)

HC (R290, R600, R600A, R1270)

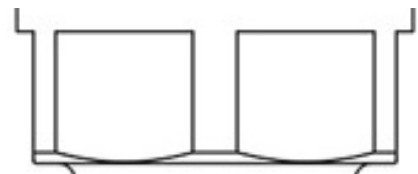

Product details

Connections SAE Flare -

Connections ODS Ø [in.] -

ODS Ø [mm] 10

Kv [m³/h] 1,5

Differential pressure (2) [bar] 0,3

PS [bar] 50

MWP [psi] (1) 600

TS [°C] min. -40

TS [°C] max. +150

Notes

(1): according to UL approval

(2): minimum pressure at which the valve is completely open