

## Product Code

# 3082/1C

Fusible Plug

1/8"NPT T=138° C

PS = 30 bar

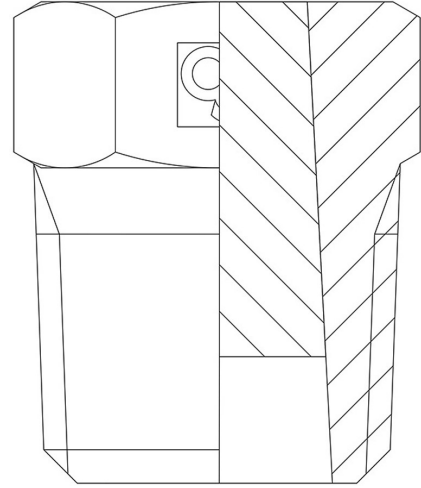

CLASSIC

### Product use

Fusible plugs are safety devices that contain a material that melts at a specific temperature and consequently vents the pressure. Safety accessories for use with the following ASHRAE 34:2019 refrigerants, Class A1:

HCFC (R22)

HFC (R134a, R404A, R407C, R410A, R507)

HFO (R1234ze)

HFO + HFC (R448A, R449A, R450A, R452A, R513A, R515A, R515B)

Alloy melting point 79 °C for plugs in series 3080. Alloy melting point 138 °C for plugs in series 3082.

### Product details

Connections NPT 1/8"

Flow section [mm<sup>2</sup>] 18,8

Kd 0,91

PS[bar] 30

Melting point [°C] 138

Max operating temperature [°C] 127

Package pcs 0