

Product Code

3125N/M28

Check Valve
28mm ODS
PS = 50 bar

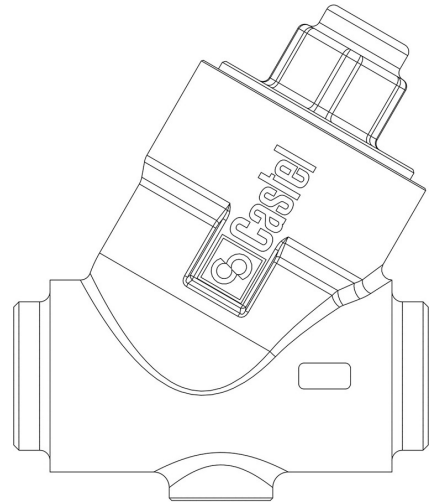

P  **LYHEDRA**

Product use

Accessories for use with the following ASHRAE 34:2019 refrigerants, Class A1, A2L, or A3:

HFC (R134A, R32, R404A, R407C, R410A, R507)

HFO (R1234YF, R1234ZE)

HFO + HFC (R448A, R449A, R450A, R452A, R452B, R454A, R454B, R454C, R455A, R513A, R515A, R515B)

HC (R290, R600, R600A, R1270)

Product details

Connections ODS Ø [in.]	-
Connections ODS Ø [mm]	28
ODM Ø [in.]	1.3/8"
ODM Ø [mm]	35
Kv [m ³ /h]	10,4
differential pressure (1) [bar]	0,3
PS [bar]	50
TS [°C] min.	-40
TS [°C] max.	+150
Package pcs	14

Notes

(1) Minimum pressure at which the valve is completely open