

Product Code

3070/44C210

Bursting Disc Safety Device
1/2"x1/2"NPT Pset=21,0bar
PS = 55 bar

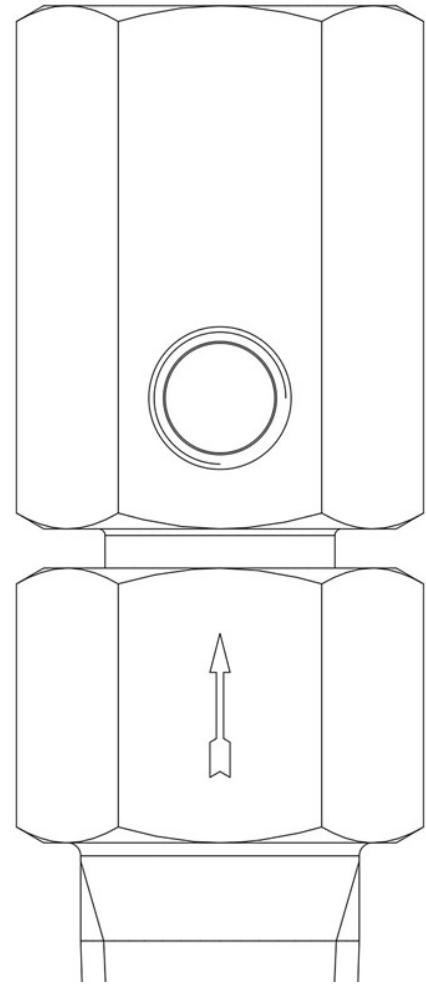

Product use

Bursting discs are safety devices designed to be installed in civil and industrial refrigeration and air conditioning systems. They act to protect equipment from any overpressure, with respect to the operating conditions for which they have been designed.

Bursting discs are manufactured from a calibrated gauge of nickel sheet, contained by a copper ring case. These discs are designed to burst at a predetermined pressure called the specified burst pressure, related to an associated temperature and a burst tolerance.

Product details

Connections male IN	1/2" NPT
Connections female OUT	1/2" NPT
service	2 x 1/8" NPT
Orifice section [mm²]	113
Bursting pressure Pb [bar]	21
Max operating pressure	75 % Pb
PS[bar]	55
TS[°C] min.	-50
TS[°C] max.	+150

