

Product Code

2028EX/4A608

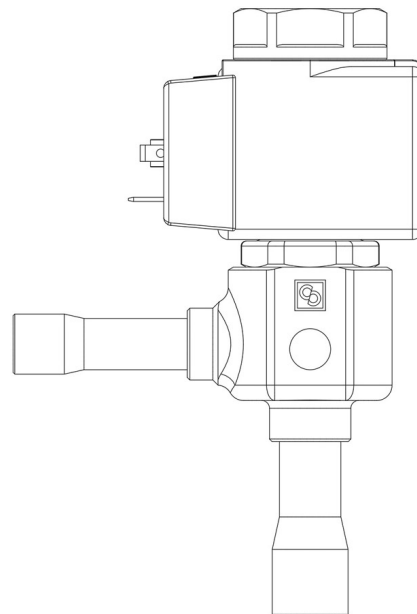

POLYHEDRA

Product use

Solenoid expansion valves with the "EX" suffix are compliant with the ESR of Directive 2014/34/EU "ATEX". This equipment is suitable for use on refrigeration systems located in areas classified as "Zone 2" risk of explosion, according to the definition in Annex I of Directive 1999/92/EC.

Accessories for use with the following ASHRAE 34:2019 refrigerants, Class A1, A2L, or A3:

HFC (R134A, R32, R404A, R407C, R410A, R507)

HFO (R1234YF, R1234ZE)

HFO + HFC (R448A, R449A, R450A, R452A, R452B, R454A, R454B, R454C, R455A, R513A, R515A, R515B)

HC (R290, R600, R600A, R1270)

These valves are only sold in the model with the ATEX certified coil (A6 suffix), with 9 nozzles assembled for an increasing output from 2 to 36 kW with R290.

Product details

Orifice type	08
Connections In Ø [in.]	1/2"
Connections In Ø [mm]	-
Out Ø [in.]	5/8"
Out Ø [mm]	-
Kv [m ³ /h]	0,23
PS [bar]	50
TS [°C] min.	-40

TS [°C] max.	+100
--------------	------

Package pcs.	15
--------------	----

Notes

for rated capacities see table of the orifice assemblies