

Product Code

6698EB/M12

3-Ways Valves to be motorized CO2

12mm ODS

PS = 140 bar

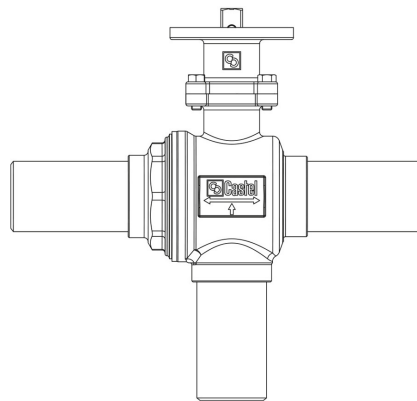

Product use

Accessories for use with refrigerant R744.

Product details

Part number (1) 6698EB/M12

Part number (1) NEW

Connections ODS Ø [in.] -

Connections ODS Ø [mm] -

W Ø [mm] 12

Ball port Ø [mm] 13,5

Kv [m³/h] 4,6

PS [bar] 140

MWP [psi] (2) 2030

TS [°C] min. -40

TS [°C] max. +150

Package pcs 1

Notes

NB: proportional flow versions available

(1): with adapter for actuators with ISO mounting flange

Castel non si assume alcuna responsabilità per eventuali errori nei cataloghi, opuscoli e altro materiale stampato o indicato nel sito Castel.it. Castel si riserva il diritto di modificare i propri prodotti senza preavviso. Tutti i marchi in questo materiale sono di proprietà di Castel. Tutti i diritti riservati.

Castel assumes no responsibility for any errors in catalogs, brochures and other material printed or indicated on the Castel.it website. Castel reserves the right to modify its products without notice. All trademarks in this material are the property of Castel. All rights reserved.

(2): according to UL approval

(3): not UL approved