

Product Code

6698E/M18

3-Ways Manual Ball Valve CO2

18mm W

PS = 140 bar

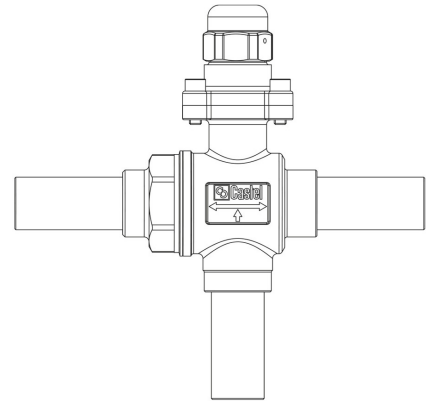

Product use

Accessories for use with refrigerant R744.

Product details

Connections W -

Connections W Ø [mm] 18

Kv [m³/h] 4,6

PS [bar] 140

MWP [psi] (1) 2030

TS [°C] min. -40

TS [°C] max. +150

Package pcs 1

Notes

NB: proportional flow versions available

(1): according to UL approval

(2): not UL approved