

Product Code

6698E/M10

3-Ways Manual Ball Valve CO2

10mm W

PS = 140 bar

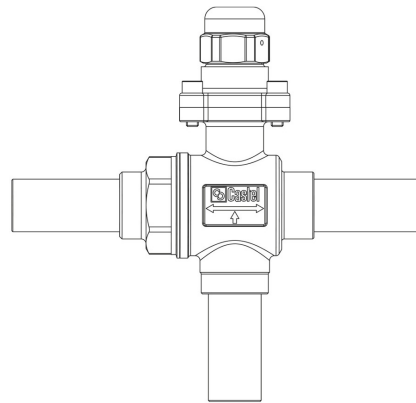

Product use

Accessories for use with refrigerant R744.

Product details

Connections W	-
Connections W Ø [mm]	10
Kv [m³/h]	4,6
PS [bar]	140
MWP [psi] (1)	2030
TS [°C] min.	-40
TS [°C] max.	+150
Package pcs	1

Notes

NB: proportional flow versions available

(1): according to UL approval

(2): not UL approved