

Product Code

**6690EM/11A2**

3-Ways Motorized Ball Valve CO2

1.3/8"-35mm ODS 24V

PS = 80 bar

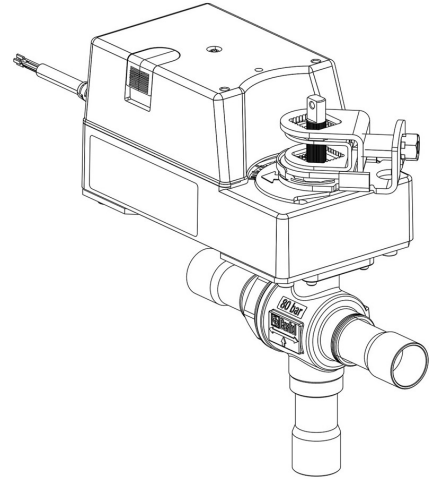

### Product use

Accessories for use with refrigerant R744.

### Product details

Part number (1) 6690EM/11A2

Part number (1)

Connections ODS Ø [in.] 1.3/8"

Connections ODS Ø [mm] 35

W Ø [mm] -

P/N Actuator 9720/RA2

Torque [Nm] 30

Ball port Ø [mm] 28

Kv [m<sup>3</sup>/h] 20,3

PS [bar] 80

TS [°C] min. -40

TS [°C] max. +150

Package pcs 1

## Notes

(1): including actuator and mounting plate

NB: proportional flow versions available