

Product Code

1338N/3S065

Pulse Solenoid Valve
3/8"ODS w/o Coil
PS = 50 bar

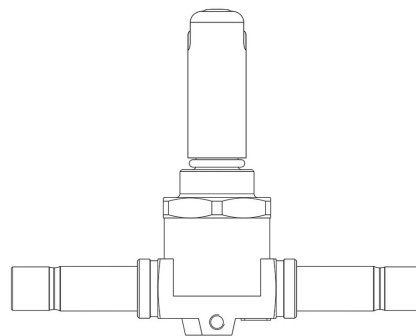

P  **LYHEDRA**

Product use

Accessories for use with the following ASHRAE 34:2019 refrigerants, Class A1, A2L, or A3:
HFC (R134A, R32, R404A, R407C, R410A, R507)
HFO (R1234YF, R1234ZE)
HFO + HFC (R448A, R449A, R450A, R452A, R452B, R454A, R454B, R454C, R455A, R513A, R515A, R515B)
HC (R290, R600, R600A, R1270)

These valves are sold in both the version without the coil (S suffix) and the version with the coil (A6 suffix for coils at 220 VAC).

Product details

Principio de funcionamiento Servomando de pistón

Dibujo img(1338N_3S.jpg)

N° catálogo 1338N/3S065

Tipo Bobina (1) HF2HF3HF4HM2HM3HM4CM2

Conexiones ODS Ø [in.] 3/8"

Conexiones ODS Ø [mm] -

Kv [m³/h] 1

PS [bar] 50

TS [°C] (2) min. -40

TS [°C] (2) max.	+150
------------------	------

Paquete de n° piezas	24
----------------------	----

Notes

(#) : para by-pass de gas caliente, inyección de líquido, línea de aceite

(1) : bobinas que pueden montarse en las válvulas

(2) : para usar en la línea de aceite TS = -10 /+ 70 ° C