

## Product Code

# 1068N/3A6

Solenoid Valve  
3/8" ODS 220-230V  
PS = 50 bar

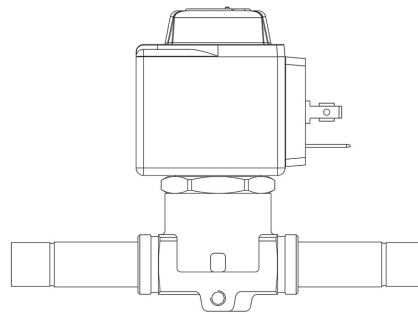

**P**  **LYHEDRA**

### Product use

Accessories for use with the following ASHRAE 34:2019 refrigerants, Class A1, A2L, or A3:  
HFC (R134A, R32, R404A, R407C, R410A, R507)  
HFO (R1234YF, R1234ZE)  
HFO + HFC (R448A, R449A, R450A, R452A, R452B, R454A, R454B, R454C, R455A, R513A, R515A, R515B)  
HC (R290, R600, R600A, R1270)

These valves are sold in both the version without the coil (S suffix) and the version with the coil (A6 suffix for coils at 220 VAC).

### Product details

**Principio de funcionamiento** Servomandode membrana

**Dibujo** img(1068N\_3A6.jpg)

**N° catálogo** 1068N/3A6

**Tipo Bobina (1)** HF2

**Conexiones ODS Ø [in.]** 3/8"

**Conexiones ODS Ø [mm]** -

**Kv [m³/h]** 0,8

**PS [bar]** 50

**TS [°C] min.** -40

TS [°C] max.	+120
--------------	------

Paquete de n° piezas	24
----------------------	----

## Notes

(1) : bobinas montadas en las válvulas