

Product Code

**1049N/7S**

Solenoid Valve  
7/8"-22mm ODS w/o Coil  
PS = 50 bar

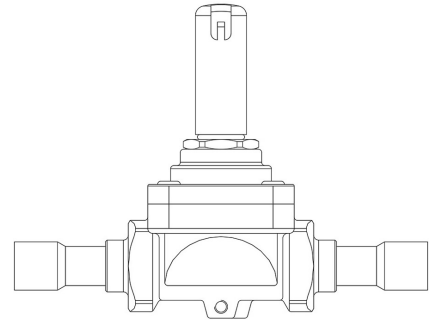

**P**  **LYHEDRA**

### Product use

Accessories for use with the following ASHRAE 34:2019 refrigerants, Class A1, A2L, or A3:  
HFC (R134A, R32, R404A, R407C, R410A, R507)  
HFO (R1234YF, R1234ZE)  
HFO + HFC (R448A, R449A, R450A, R452A, R452B, R454A, R454B, R454C, R455A, R513A, R515A, R515B)  
HC (R290, R600, R600A, R1270)

These valves are sold in both the version without the coil (S suffix) and the version with the coil (A6 suffix for coils at 220 VAC).

### Product details

**Principio de funcionamiento** Servomando de pistón

**Dibujo** img(1048N\_4S.jpg)

**N° catálogo** 1049N/7S

**Tipo Bobina (1)** HF2HF3HF4HM2HM3HM4CM2

**Conexiones ODS Ø [in.]** 7/8"

**Conexiones ODS Ø [mm]** 22

**Kv [m³/h]** 3

**PS [bar]** 50

**TS [°C] min.** -40

TS [°C] max.	+130
Paquete de n° piezas	14

## Notes

(1) bobinas que pueden montarse en las válvulas