

Product Code

1038N/M12S

Solenoid Valve
12mm ODS w/o Coil
PS = 50 bar

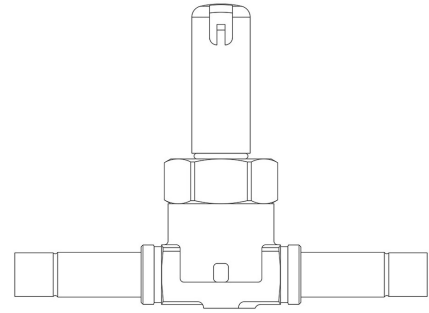

P  **LYHEDRA**

Product use

Accessories for use with the following ASHRAE 34:2019 refrigerants, Class A1, A2L, or A3:
HFC (R134A, R32, R404A, R407C, R410A, R507)
HFO (R1234YF, R1234ZE)
HFO + HFC (R448A, R449A, R450A, R452A, R452B, R454A, R454B, R454C, R455A, R513A, R515A, R515B)
HC (R290, R600, R600A, R1270)

These valves are sold in both the version without the coil (S suffix) and the version with the coil (A6 suffix for coils at 220 VAC).

Product details

Principio de funcionamiento Servomando de pistón

Dibujo img(1038N_3S.jpg)

N° catálogo 1038N/M12S

Tipo Bobina (1) HF2HF3HF4HM2HM3HM4CM2

Conexiones ODS Ø [in.] -

Conexiones ODS Ø [mm] 12

Kv [m³/h] 1

PS [bar] 50

TS [°C] min. -40

TS [°C] max.	+130
Paquete de n° piezas	24

Notes

(1) bobinas que pueden montarse en las válvulas