

Product Code

1079/7A6

Solenoid Valve
7/8"-22mm ODS 220-230V
PS = 45 bar

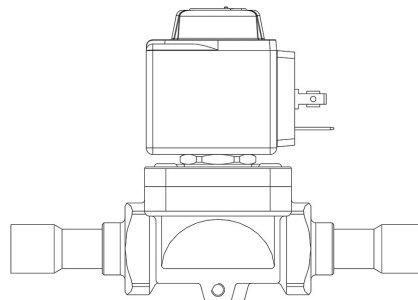

CLASSIC

Product use

Accessories for use with the following ASHRAE 34:2019 refrigerants, Class A1:

HCFC (R22)

HFC (R134a, R404A, R407C, R410A, R507)

HFO (R1234ze)

HFO + HFC (R448A, R449A, R450A, R452A, R513A, R515A, R515B)

These valves are sold in both the version without the coil (S suffix) and the version with the coil (A6 suffix for coils at 220 VAC and A7 suffix for coils at 240 VAC).

Product details

Principio de funcionamiento Servomandode membrana

Dibujo img(1078_4A6.jpg)

N° catálogo 1079/7A6

Tipo Bobina (1) HF2

Conexiones ODS Ø [in.] 7/8"

Conexiones ODS Ø [mm] 22

Kv [m³/h] 2,61

PS [bar] 45

TS [°C] min. -35

TS [°C] max. +105

Notes

(1) : bobinas montadas en las válvulas